

# ECOTAP LOADBALANCER & PLAZA GRID INSTALLEREN





## INHOUD

Loadbalancer installeren

---

03

Plaza Grid installeren

---

31



# Loadbalancer(Utility Meter) installeren

# Compatible meters



Eastron SDM 630



ABB B23 / B24 Modbus

# Loadbalancer aansluiten



De Loadbalancer (Utility Meter) wordt gemonteerd in de meterkast of verdeler

# Loadbalancer aansluiten



**Directe Loadbalancer (Utility Meter) wordt gemonteerd in de meterkast of verdeler**

# De Directe loadbalancer (Utility meter) Power en Mod bus aansluiting



## Data connection from (master) chargingstation to the gridmeter



### (Master) Chargingstation

At a homebox charging point, no kWh meter with address 2 is installed, the data wiring then runs from kWh with address 1 directly to the terminals at the bottom of the charging station.  
When multiple charging stations are used in a master/slave network.  
Connect the data cable from the gridmeter to the **master** of the network.

At any point between the white and orange wires, a multimeter reads 60 Ohms. (please measure with power removed)

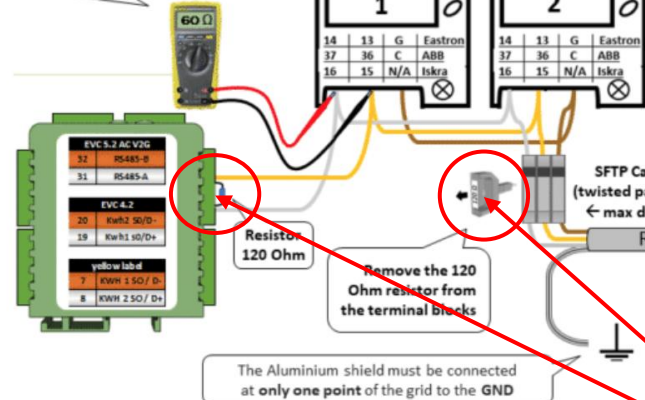

### Utility-Meter

We support the following meters:

- EASTRON SDM630
- ABB B23 / B24 Modbus

Make sure the gridmeter has a **Modbus RS485** connection

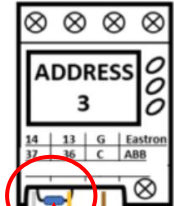

Make sure the gridmeter is set to the following setting:  
Address: 3  
Eastron BaudRate: 9600  
ABB BaudRate: 38400  
Parity: None  
StopBit: 1

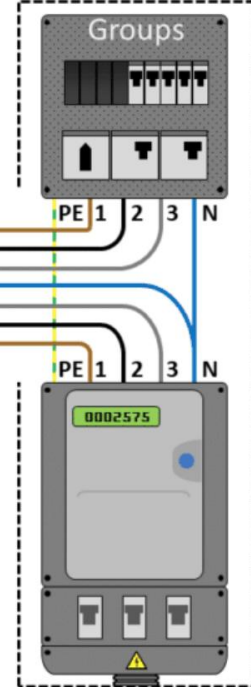
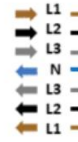

Let op

120 Ω

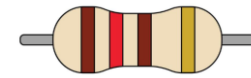

Zie volgende slide

# De Directe loadbalancer (Utility meter) Power en Mod bus aansluiting

- De Utility meter wordt gemonteerd in de meterkast of verdeler tussen de hoofschakelaar en de groepenkast.
- De 1 of 3 fase's worden rechtstreeks op de Utility meter aangesloten.
- De modbus aansluiting loopt van de modbus aansluiting van de Utility Meter naar de modbus aansluiting in de EVC charger.
- Voor je de Modbus aansluit meet je de ohmse waarde tussen oranje en wit:
  - a. Bij 60 ohm verwijder de 120 ohm weerstand onder in de charger
  - b. Bij 120 ohm laat de situatie zoals hij is .
- Indien geen modbus aansluiting in de EVC charger dan aansluiten op de modbus van een van de kWh meters
- Sluit nu de Modbus aan in de EVC charger
- Meet de ohmse waarde op de Modbus tussen oranje en wit:
  - De ohmse waarde moet altijd 60 ohm zijn

# Aansluiting in de meterkast of verdeler:

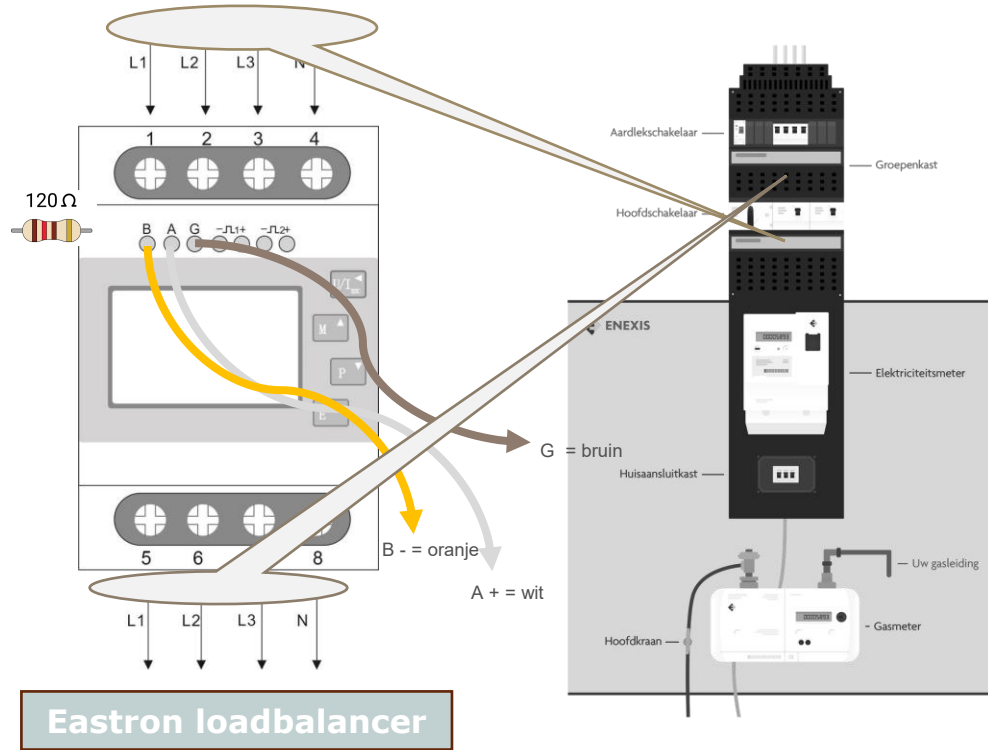

# ABB Indirecte loadbalancer (Utility meter) Power en Mod bus aansluiting

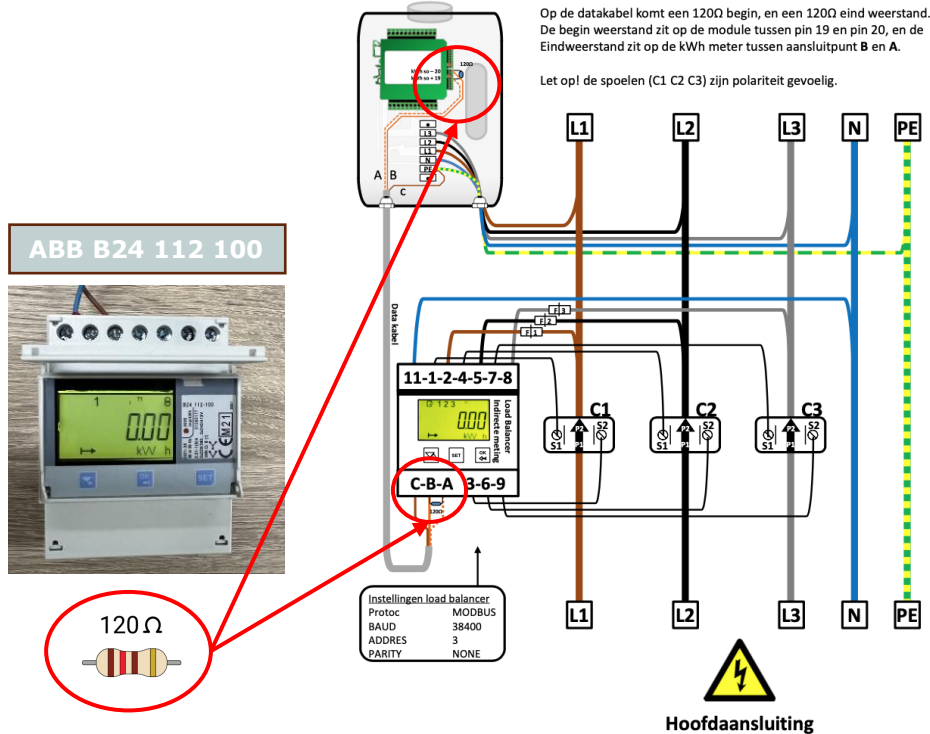

Voorbeeld van een stroomtrafo (C1, C2 en C3)

# Eastron Indirecte loadbalancer (Utility meter) Power en Mod bus aansluiting

Eastron SDM630MCT V2



Naar groepenkast

RS485 aansluiting

A = + (wit)  
B = - (Oranje)  
G = GND (bruin)  
Weerstand 120 ohm  
tussen A- en B+

120  $\Omega$

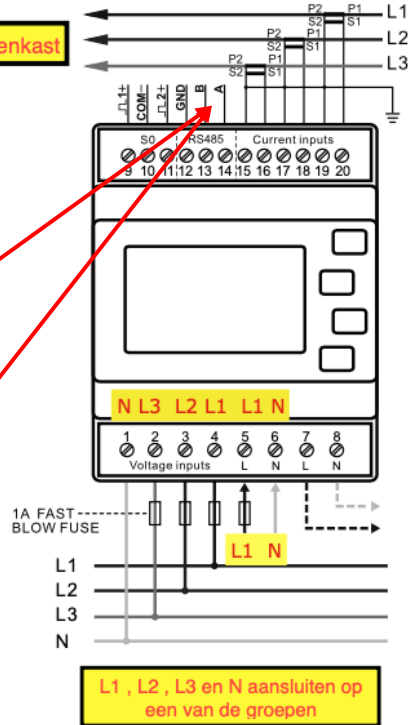

Voorbeeld van een stroomtrafo (C1, C2 en C3)

# Schema van de kWh meters in de EVC charger Power en modbusaansluiting

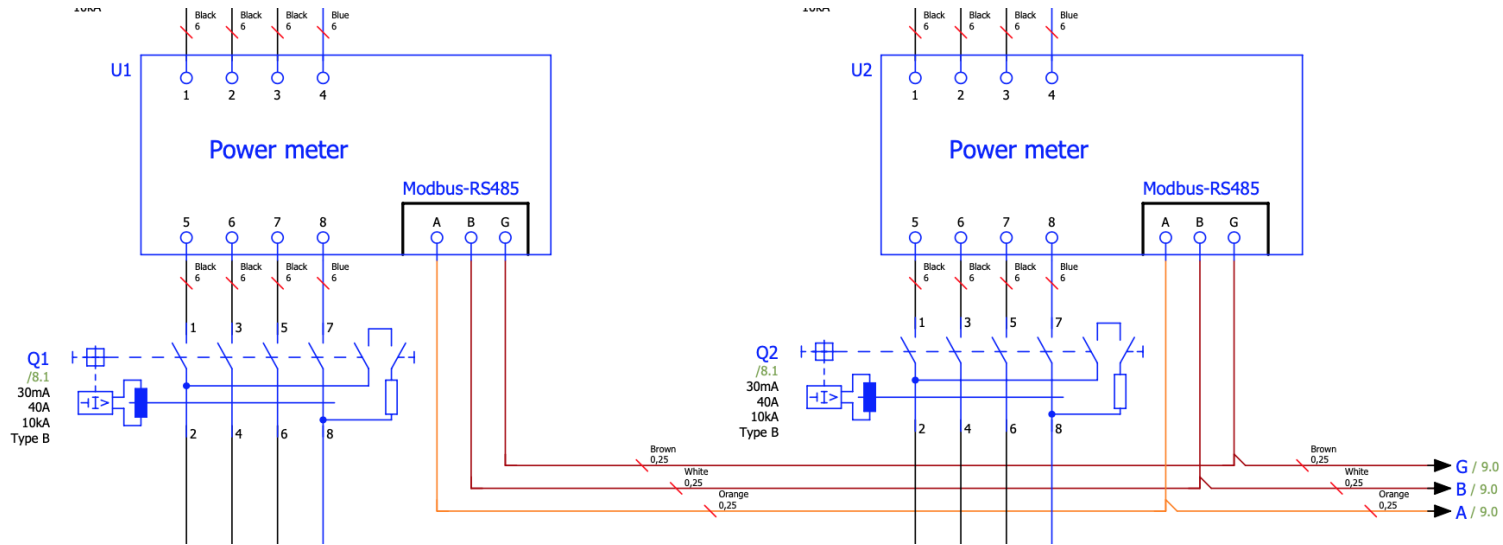

A B G (Ground)  
=  
A B C (Common)

# Schema van de Modbus en Canbus onderin de EVC charger

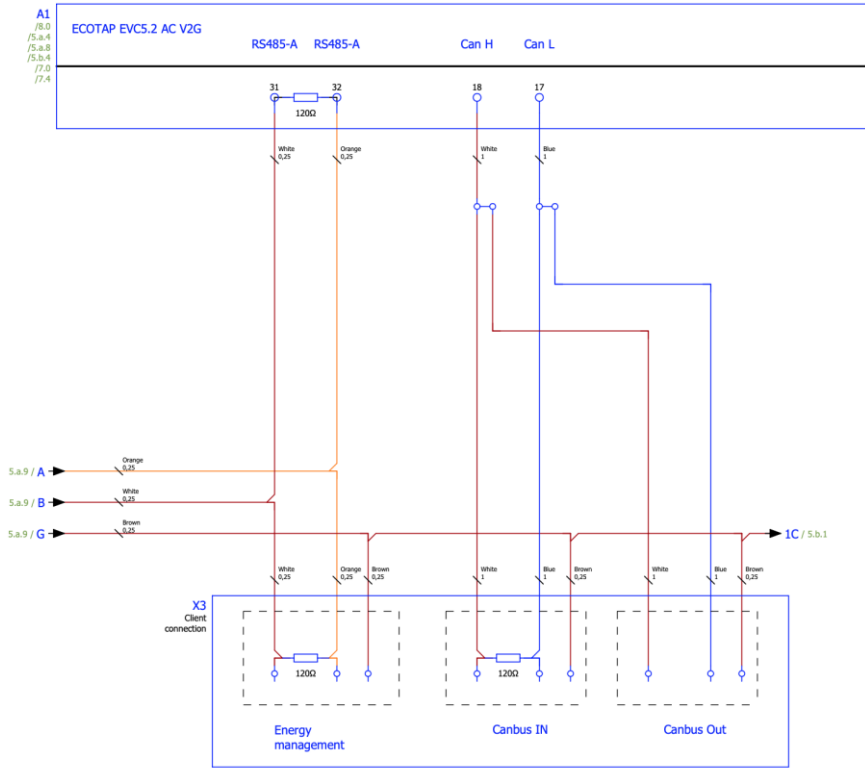

# DUO Charger loadbalancer Mod-bus connection



Zie volgende pagina.

# DUO Charger loadbalancer Mod-bus connection

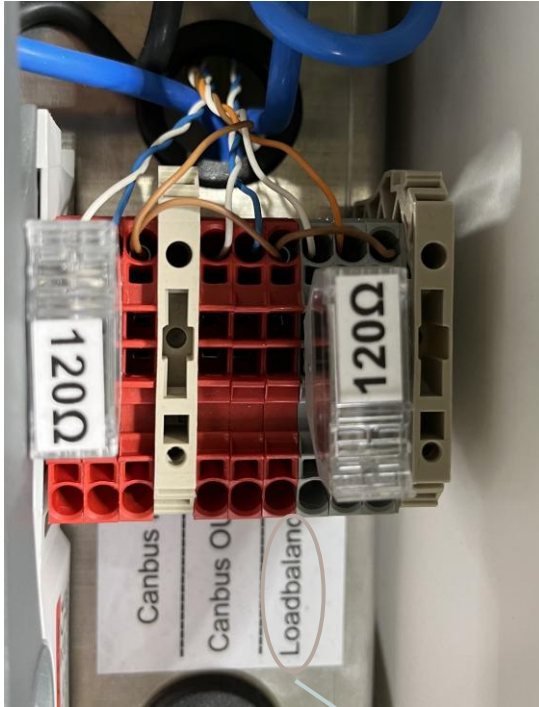

Loadbalancer

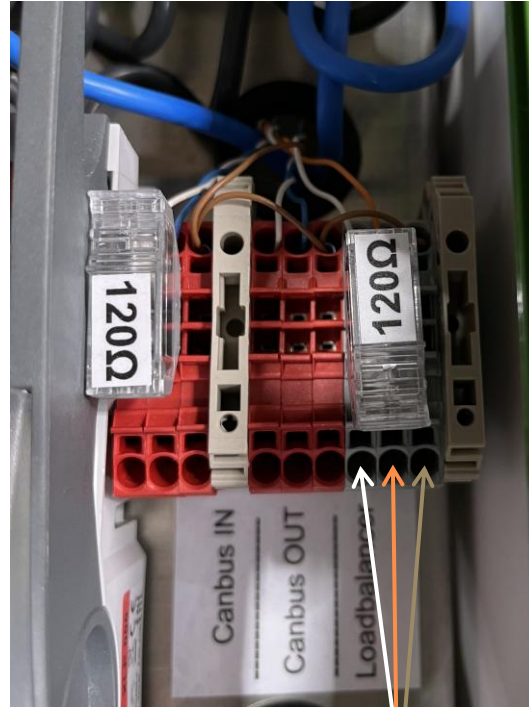

Naar loadbalancer  
wit-oranje- bruin

Verwijder de 120 Ohm weerstand in the charger, alleen als er al een 120 ohm weerstand op de EVC module of kWh meter zit  
Plaats een 120 Ohm weerstand op de loadbalancer

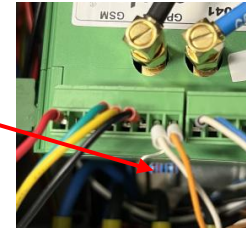
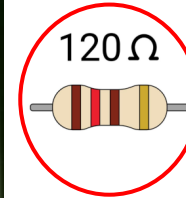

# Single Wall Charger loadbalancer Mod-bus connection

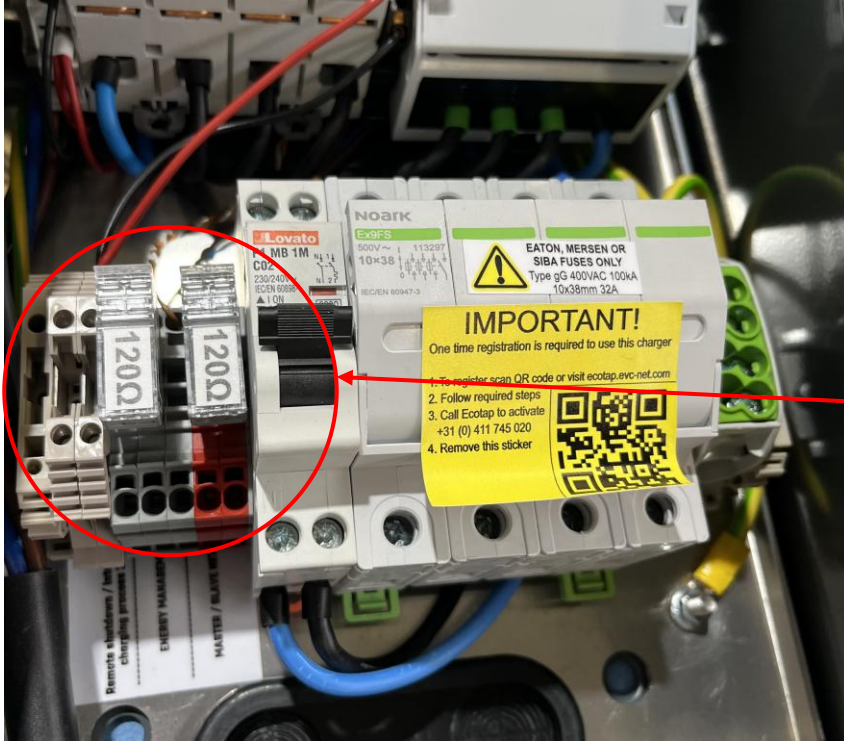

Zie volgende pagina

# Single Wall Charger loadbalancer Mod-bus connection

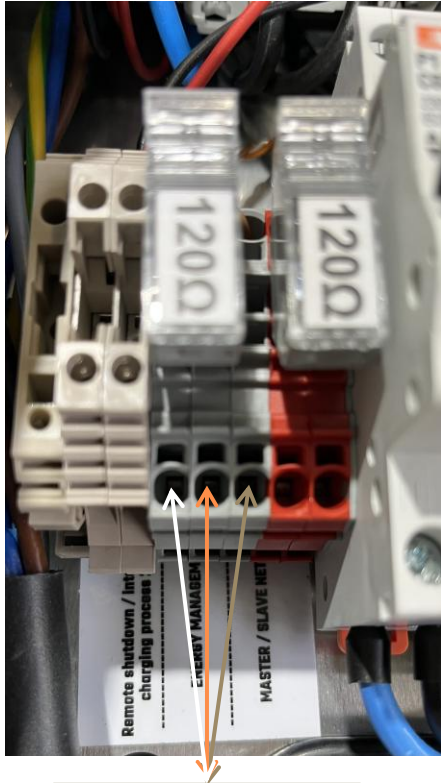

Verwijder de 120 Ohm weerstand in the charger, alleen als er al een 120 ohm weerstand op de EVC module of kWh meter zit.

Plaats een 120 Ohm weerstand op de loadbalancer (zie volgende sheet)

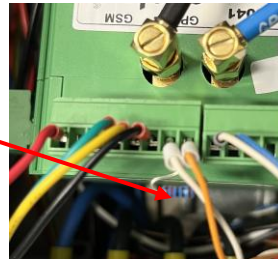
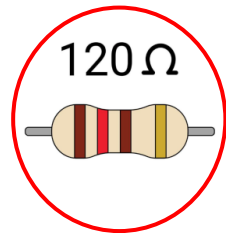

Naar loadbalancer  
wit-oranje-bruin

# Loadbalancer Mod-bus connection in de meterkast of verdeler

Naar EVC Charger  
oranje-wit-bruin

Eastron SDM630MCT  
loadbalancer



ABB B23 loadbalancer

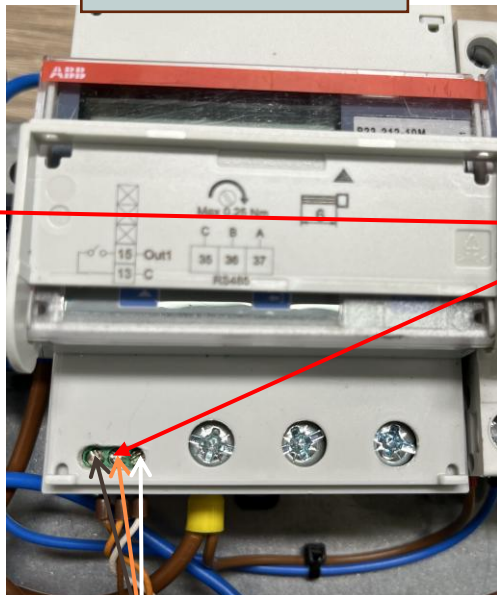

Plaats een 120 Ohm weerstand  
op de loadbalancer tussen  
oranje en wit

120  $\Omega$



Naar EVC Charger  
bruin-oranje-wit

# Eastron SDM630MCT instellen

# Eastron SDM630MCT instellen

## 4 Set Up

To enter set up mode, hold the  button for 3 seconds, until the password screen appears.



The set up is password-protected so you must enter the correct password (default '1000') before processing.

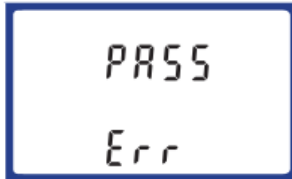

If an incorrect password is entered, the display will show:

PASS Err (Error)

To exit the set up menu, hold the  for 3 seconds, the measurement screen will display.













## Set Up

1. Druk 2 sec op E -> Pass 0000
2. Password = 1000
3. Select met M -> Pass 1000
4. Houd 2 sec E ingedrukt -> Set Addr 001
5. Ga naar volgende pagina

# Eastron SDM630MCT instellen

## 4.8.1 RS485 Address

	Use the  and  buttons to select the menu option. The screen will show the current setting.
	Hold the  button to set the meter Address. Range: 001(default) to 247.
	Hold the  button to confirm the selection.









Use the  and  buttons to choose the necessary number, then press the  button to move along to the next number. To save the new setting, hold the  button for 3 seconds until the selection stops flashing.



**Address : 003**

# Eastron SDM630MCT instellen

## 4.8.2 Baud Rate

	Use the  and  buttons to select the menu option. The screen will show the current setting.
	Hold the  button to enter the menu option, the current selection will flash.
	Use the  and  buttons to select the required option.









On completion of the entry procedure, hold the  button to confirm the setting.



**Baud rate : 9.6**

# Eastron SDM630MCT instellen

## 4.8.3 Parity

	Use the  and  buttons to select the menu option. The screen will show the current setting.
	Hold the  button to enter the menu option, the current selection will flash.
	Use the  and  buttons to select the required option. Range: None (default), Odd or Even.

On completion of the entry procedure, hold the  button for 3 seconds until the selection stops flashing.





**Parity : none**

# Eastron SDM630MCT instellen

## 4.8.4 Stop bits



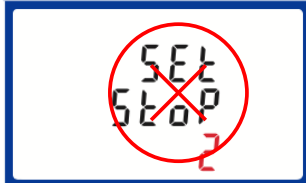

Use the  and  buttons to select the menu option. The screen will show the current setting.



Hold the  button to enter the menu option, the current selection will flash.



Use the  and  buttons to select the required option.  
Range: 1 (default) or 2.

On completion of the entry procedure, hold the  button for 3 seconds until the selection stops flashing.









**Stop bit : 1**

# Dit alleen instellen bij een indirecte loadbalancer met Current Transformers

## 4.4 CT Configuration

The CT options set the Secondary Current (CT2 5A or 1A) of the Current Transformer (CT) that are used with the meter.

	Use the <b>MID</b>  and <b>P</b>  buttons to select the menu option. The screen will show the current setting.
	Secondary CT Setting: Hold the <b>E</b>  button to set the CT secondary option: 5A (default) or 1A.
	Set the CT Ratio Value: Hold the <b>E</b>  button to enter the CT Ratio setting screen. The range is from 0001 to 9999.

The CT Rate is the CT Primary divided by the CT Secondary. For Example: 200/5A Current Transformers -  $200 \div 5 = 40$ , so the CT Rate would be 0040 and the CT2 would be 5.

**On the MID Version, you can only program the CT Rate ONCE.**



## Instellen Current Transformer (CT)

[https://www.youtube.com/watch?v=ucx8SezG\\_7o](https://www.youtube.com/watch?v=ucx8SezG_7o)

# Dit alleen instellen bij een indirecte loadbalancer met Current Transformers

## Configuratie Eastron KWh-meter

Instellen van de Eastron SDM630-Modbus V2



1. Houd <Enter> 2 seconden ingedrukt
2. Voer het juiste Password in met <Omhoog> en <Omlaag> (standaard Password = 1000)
3. Houd <Enter> 2 seconden ingedrukt. ('Set Addr' verschijnt nu in het scherm)
4. Met de pijlen <omhoog> <omlaag> kan je de juiste parameter selecteren.
5. Houd <Enter> nogmaals 2 seconden ingedrukt om de juiste parameter in te stellen.
6. Stel de juiste waarde in met <Omhoog>, <Omlaag> en <Enter/Rechts>
7. Houd <Enter> 2 seconden ingedrukt om waarde te bevestigen. 'Good' is kort zichtbaar
8. Druk op <terug> om terug te keren naar het juiste scherm

Waardes:

Addr (kassa1) 1 (kassa2) 2 (loadbalancer) 3 Baudrate 9,6 PAR NONE Stop 1



# ABB B23 Modbus instellen

# ABB B23 Modbus instellen

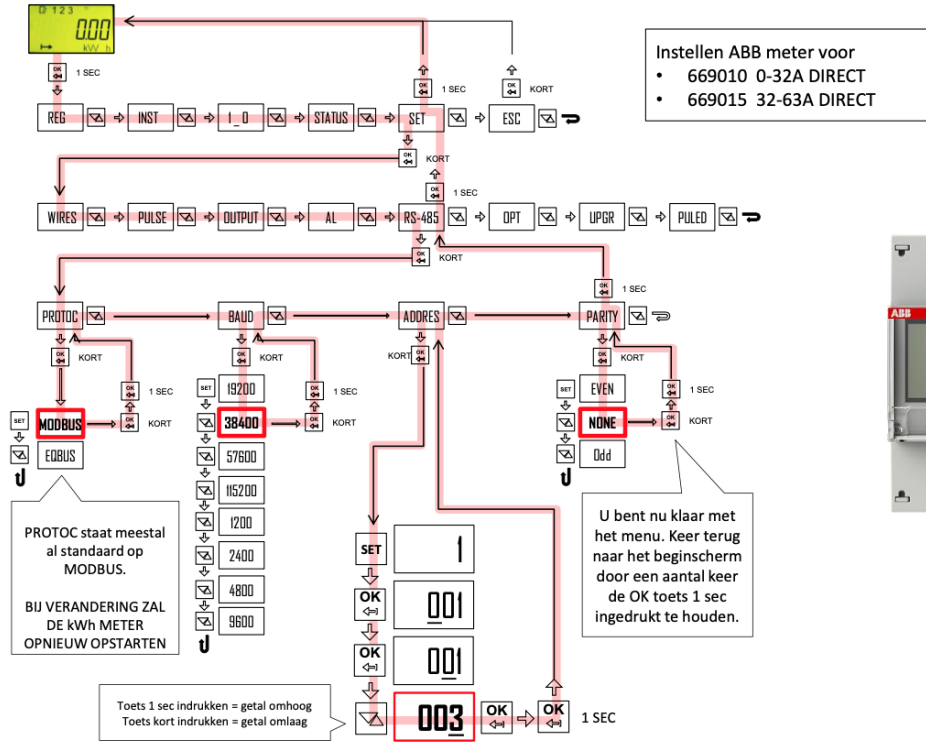

# ABB B23 Modbus instellen

## Open de plastic afdekking aan de voorkant

(Met de afdekking gesloten kunt u niet op de SET-toets drukken.)

1. Druk op SET-toets. De LCD geeft "RS-485" weer.
2. Druk op OK. De LCD toont "Prot" (protocol).
3. Druk op de toets omlaag. LCD toont "baud". Druk dan op OK.
4. Het actuele baudgehalte wordt op het scherm getoond.
5. Druk op SET. Het scherm begint te knipperen.
6. Druk op de toets omlaag tot "38400" getoond wordt. Druk dan op OK.
7. Druk en houd OK gedurende een seconde ingedrukt om terug te keren naar het vorige menu. Het toont "baud" opnieuw.
8. Druk op de pijl omlaag tot "Adress" wordt weergegeven. Druk op OK. De huidige instelling wordt weergegeven (fabrieksstandaard "1").
9. Druk op SET. De weergaven knippert.
10. Druk op de omlaag-toets tot "003" wordt weergegeven. Druk op OK.
11. Druk en houd OK voor een seconde om terug te keren naar het vorige menu
12. Druk op toets omlaag tot "Parity".
13. Druk op OK en vervolgens op set en selecteer "none"
14. Druk op OK en houd de toets voor 1 sec ingedrukt om terug te gaan naar het vorige menu.
15. Herhaal dit 3 keer om terug te keren naar het beginscherm.

# Checklist installeren loadbalancer (Utility Meter)

1. Controleer de 3 fase spanningen op de Utility Meter in de meterkast:
  - L1 ->N = 230V
  - L2 ->N = 230V
  - L3 ->N = 230V
  - L1 ->L2 = 400V
  - L1 ->L3 = 400V
  - L2 ->L3 = 400V
  - N - Earth = 0V
2. Controleer of de draden goed zijn gemonteerd onder de klemmen
3. Controleer de Mod bus aansluiting
4. Meet de weerstand op de Mod bus tussen A en B = 60 ohm  
Let op deze weerstandswaarde dient altijd 60 Ohm te zijn
5. Controleer de juiste parameters op de Utility Meter:

# Plaza Grid installeren incl. instellingen

# Power connection 3 mogelijkheden

## 1. Doorlussen via de EVC chargers ( Let op max 80A)

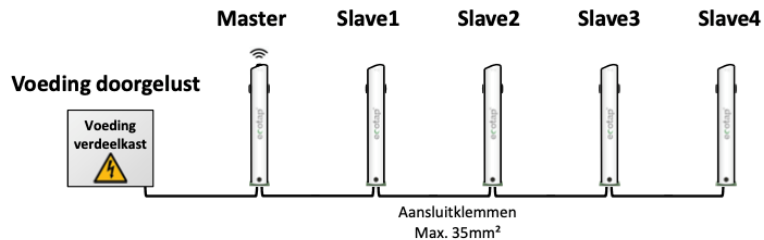

## 2. Elke EVC charger een aparte voeding (Ster verbinding)

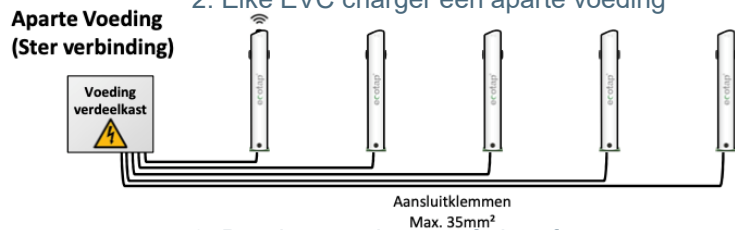

## 3. Doorlussen via een aftakmof

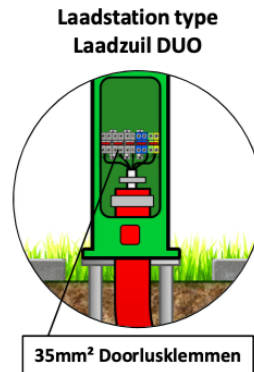
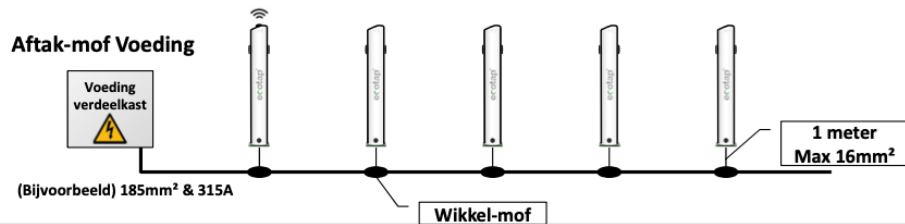

# Schema van de Power aansluitingen

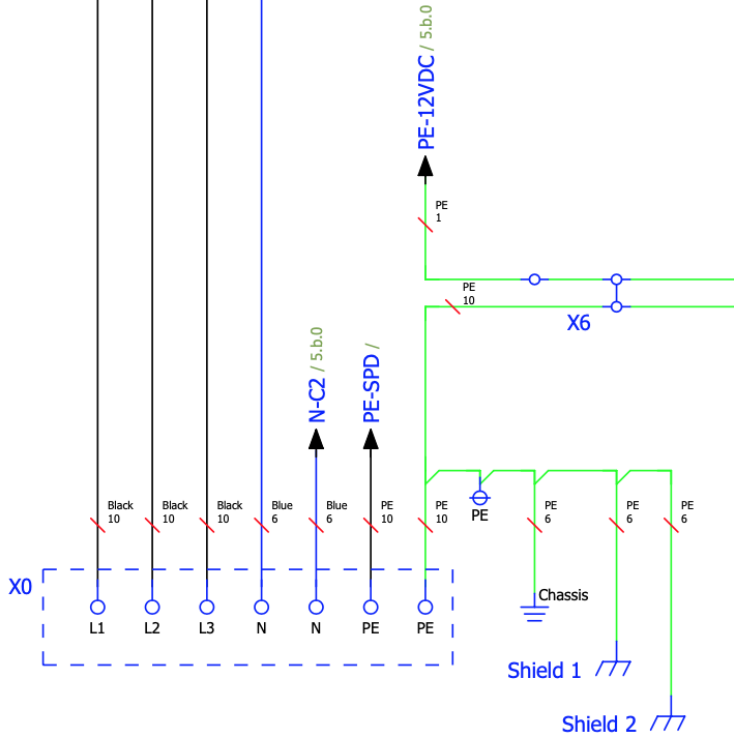

# Schema van de Power aansluitingen

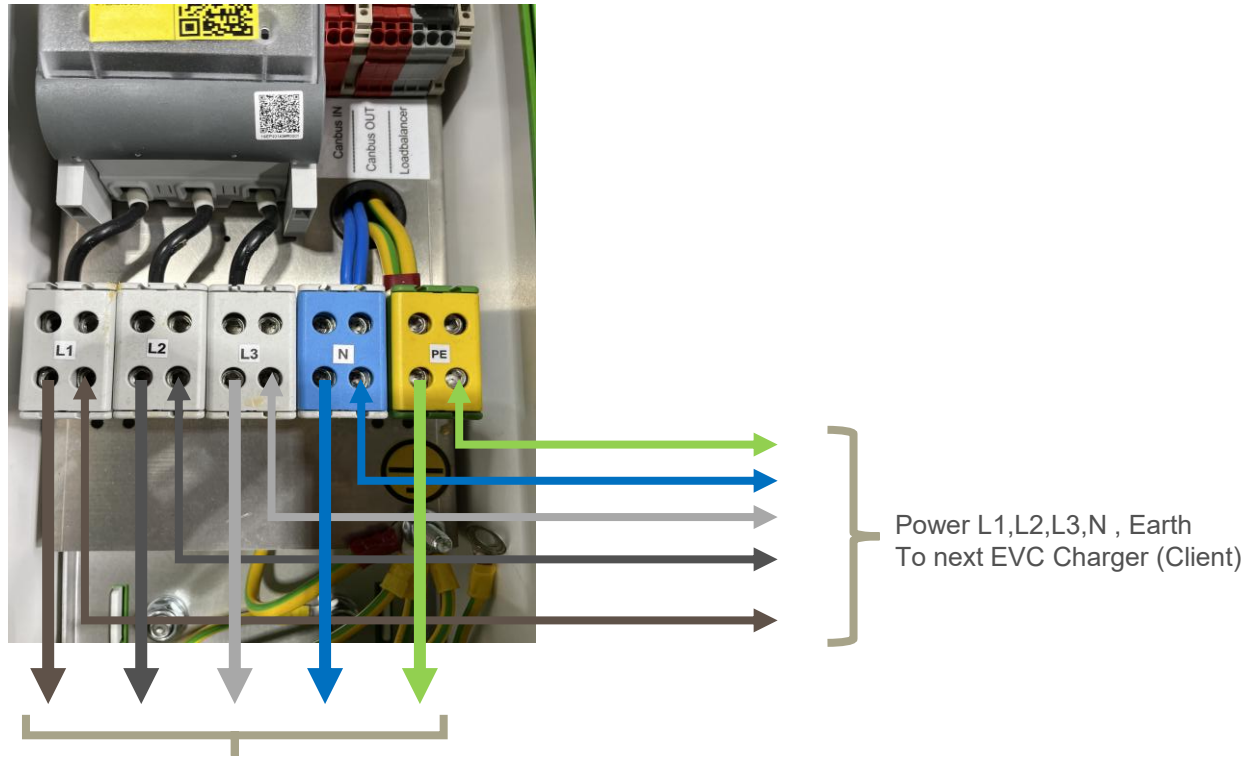

Power connection L1,L2,L3,N , Earth

# Can bus connection

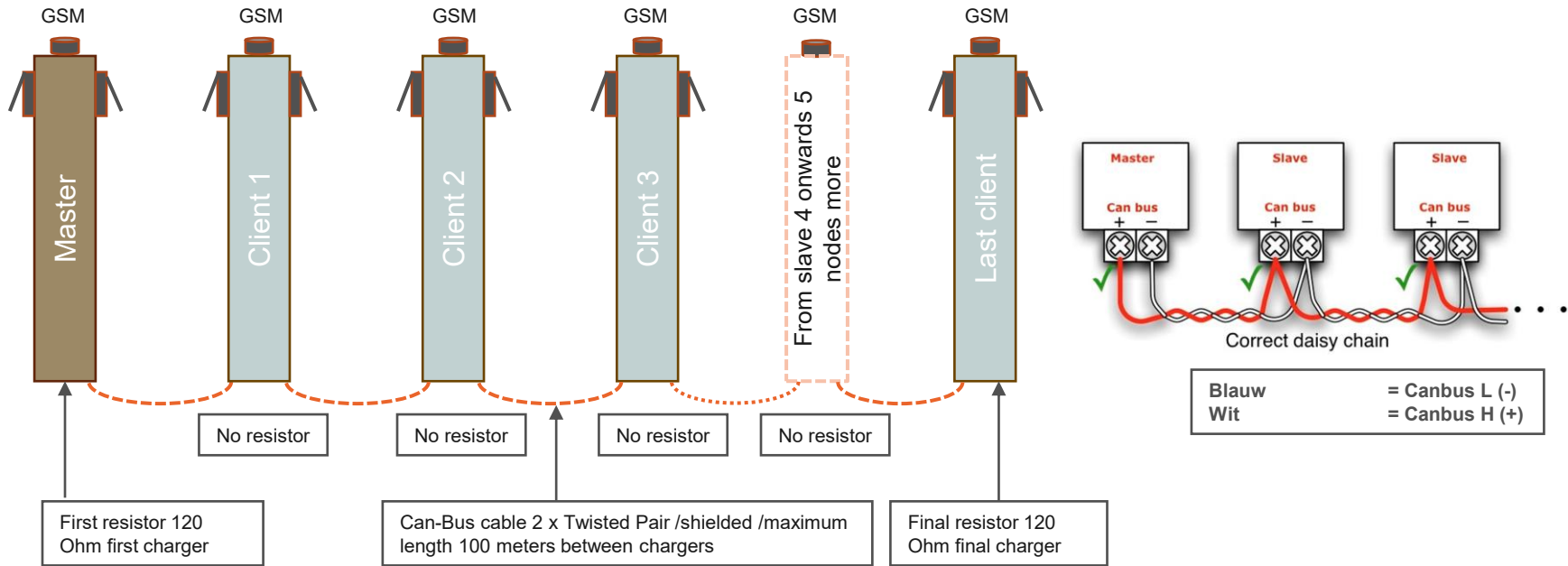

Note : Maak **GEEN STERVERBINDING** van de canbus kabel maar een Daisy Chain verbinding.  
Gebruik **EEN** paar getwiste draad van de Cat kabel : blauw/wit.

# Doorlussen van de Canbus cable via Canbus in en out.

Deze klemmen worden toegepast in de laatste modellen Chargers.

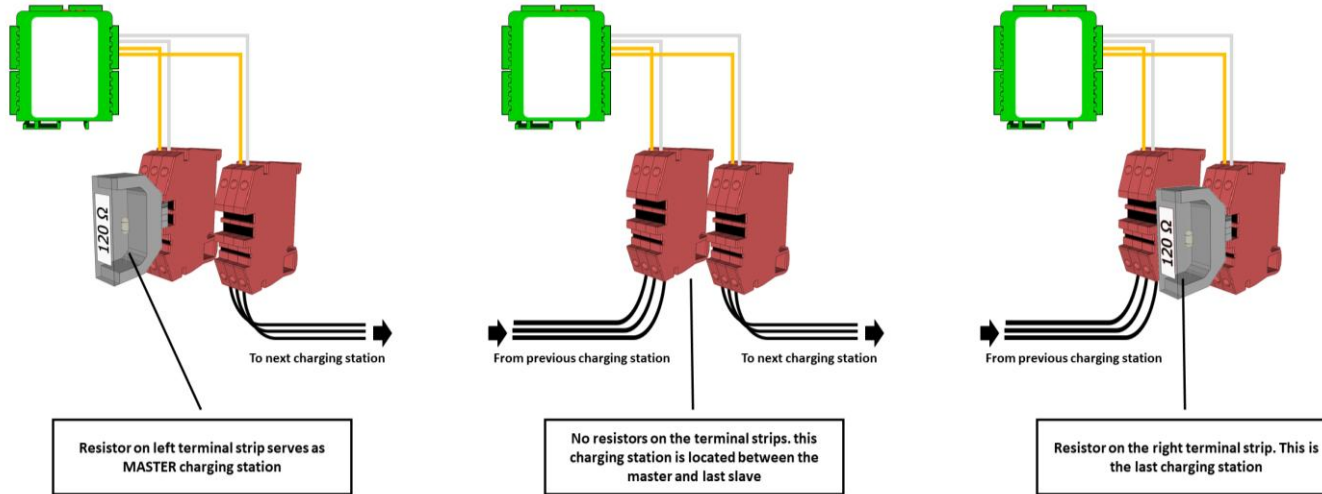

Blauw = Canbus L (-)  
Wit = Canbus H (+)

# Gebruik NOOIT een sterverbinding voor het doorlussen van de canbus

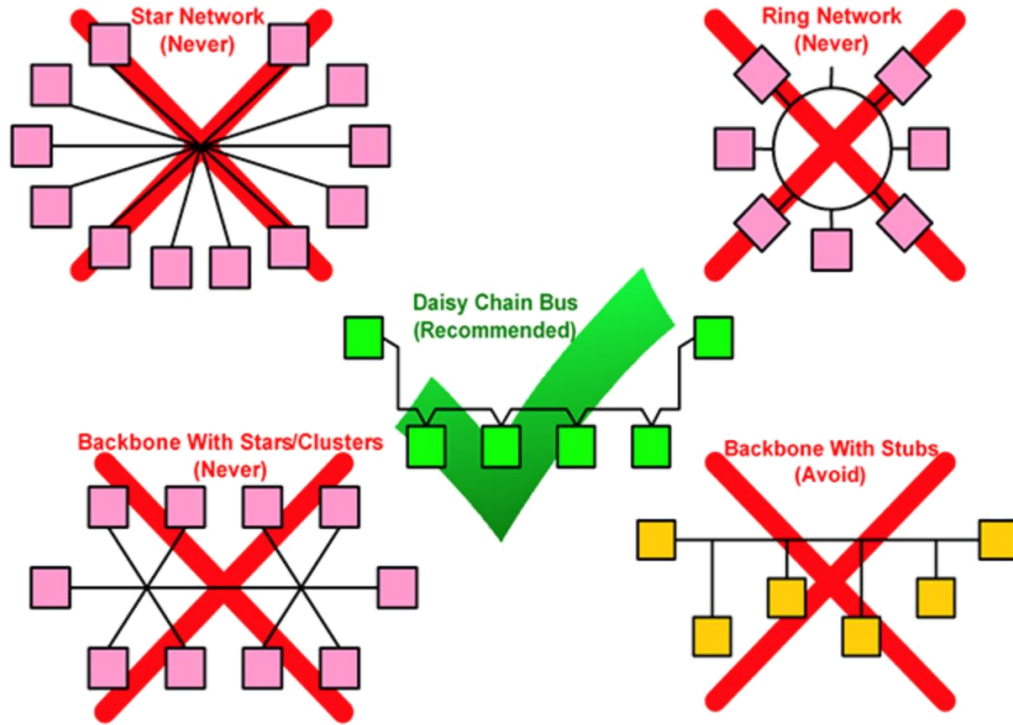

*Master/Client Device Connection not Recommended*

# Master / Client

Master

Client

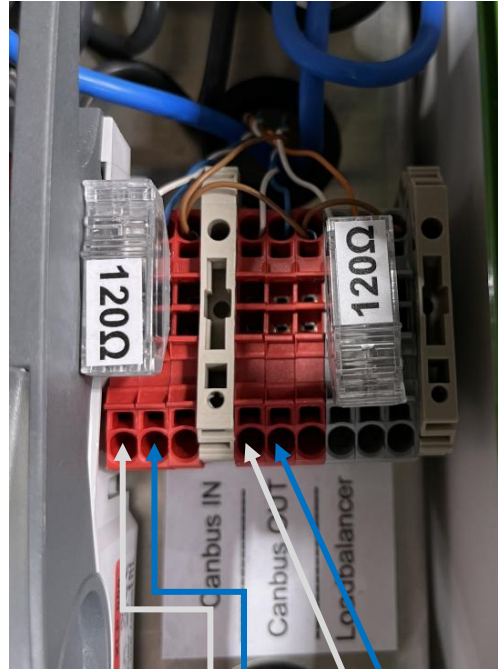

Blauw	= Canbus L
Wit	= Canbus H



# Master / Client

Master

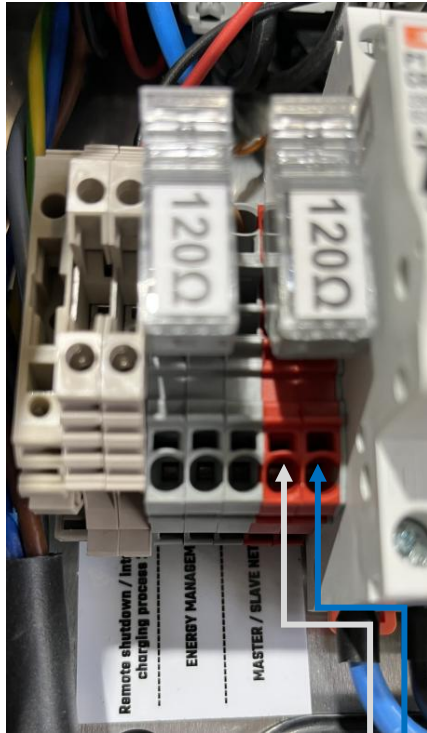

Client

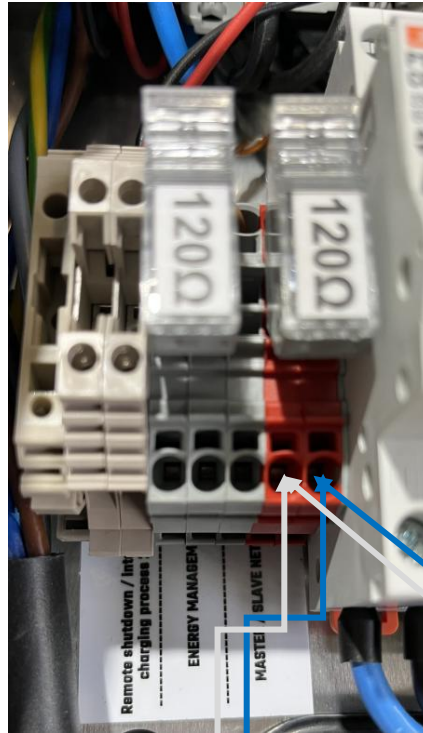

To the next client  
Twisted cable

Blauw = Canbus L (-)  
Wit = Canbus H (+)

Twisted cable

# Checklist installeren Master-Client connection

1. Controleer de 3 fase spanningen op de Utility Meter in elke lader:
  - L1 ->N = 230V
  - L2 ->N = 230V
  - L3 ->N = 230V
  - L1 ->L2 = 400V
  - L1 ->L3 = 400V
  - L2 ->L3 = 400V
  - N - Earth = 0V
2. Controleer of de draden goed zijn gemonteerd onder de klemmen
3. Controleer de CAN-bus aansluiting
  - Witte draad = CAN-bus H
  - Blauwe draad= CAN-bus L
  - Wit op Wit – Blauw op Blauw
4. Meet de weerstand over de CAN-bus tussen Can H en Can L
  - Let op deze weerstandswaarde dient altijd 60 Ohm te zijn

# Videos ter ondersteuning

---

Ter verduidelijking zijn de volgende video's beschikbaar.

1. Ecotap Duo- Het opbouwen van een Plaza grid:

[Opbouwen van een Plaza Grid \(Plaza\) – Ecotap Kennisbank](#)

2. Ecotap Duo- Het aansluiten van een loadbalancer:

[Aansluiten van een loadbalancer \(Ecotap DUO\) – Ecotap Kennisbank](#)

3. Single Wallcharger- Het aansluiten van een loadbalancer:

[Aansluiten van een loadbalancer \(Single Wallcharger\) – Ecotap Kennisbank](#)

# Disclaimer

---

**LET OP** controleer voor de laatste actuele versie altijd onze support pagina op:

<https://ecotap.zendesk.com/hc>

## **Ecotap B.V.**

Kruisbroeksestraat 23

5281 RV Boxtel

The Netherlands

+31(0) 411 210 210

[info@ecotap.nl](mailto:info@ecotap.nl)

<https://www.ecotap.nl>